



(12) **United States Design Patent**
Feit et al.

(10) **Patent No.:** **US D804,459 S**
(45) **Date of Patent:** **** Dec. 5, 2017**

- (54) **ANTENNAS**
- (71) Applicant: **ANTENNAS DIRECT, INC.**,
Ellisville, MO (US)
- (72) Inventors: **Corey Feit**, St. Louis, MO (US); **John Edwin Ross, III**, Moab, UT (US);
Richard E. Schneider, Wildwood, MO (US)
- (**) Term: **15 Years**
- (21) Appl. No.: **29/587,280**
- (22) Filed: **Dec. 12, 2016**

Related U.S. Application Data

(63) Continuation-in-part of application No. 29/580,046, filed on Oct. 5, 2016, and a continuation-in-part of application No. 29/580,049, filed on Oct. 5, 2016, and a continuation-in-part of application No. 14/308,422, filed on Jun. 18, 2014, now abandoned, and a continuation-in-part of application No. 29/430,632, filed on Aug. 28, 2012, now abandoned, which is a continuation-in-part of application No. 29/376,791, filed on Oct. 12, 2010, now Pat. No. Des. 666,178, said application No. 14/308,422 is a continuation-in-part of application No. 13/759,750, filed on Feb. 5, 2013, now Pat. No. 8,994,600, which is a continuation-in-part of application No. 12/606,636, filed on Oct. 27, 2009, now Pat. No. 8,368,607, which is a continuation-in-part of application No. 12/050,133, filed on Mar. 17, 2008, now Pat. No. 7,609,222, which is a continuation-in-part of application No. 29/304,423, filed on Feb. 29, 2008, now Pat. No. Des. 598,433, said application No. 12/606,636 is a continuation-in-part of application No. 12/040,464, filed on Sep. 29, 2008, now Pat. No. 7,839,347, said application No. 12/606,636 is a continuation-in-part of application No. 29/305,294, filed on Mar. 17, 2008, now Pat. No. Des. 604,276, which is a continuation-in-part of

(Continued)

(51) **LOC (10) Cl.** **14-03**

- (52) **U.S. Cl.**
USPC **D14/230**
- (58) **Field of Classification Search**
USPC D14/42, 43
CPC H01L 33/48; H01L 23/02; H01Q 7/00;
H01Q 13/10
See application file for complete search history.

(56) **References Cited**

U.S. PATENT DOCUMENTS

2,060,098 A 11/1936 Norman
2,220,008 A 10/1940 Woodward et al.
(Continued)

FOREIGN PATENT DOCUMENTS

CN 201243084 Y 5/2009
CN ZL2008200072832 5/2009
(Continued)

Primary Examiner — John Windmuller
Assistant Examiner — Benjamin Weeks
(74) *Attorney, Agent, or Firm* — Harness, Dickey & Pierce, P.L.C.

(57) **CLAIM**

The ornamental designs for antennas, as shown and described.

DESCRIPTION

FIG. 1 is a perspective view of an antenna, showing our new design;
FIG. 2 is a back perspective view of the antenna shown in FIG. 1;
FIG. 3 is a front view of the antenna shown in FIG. 1;
FIG. 4 is a back view of the antenna shown in FIG. 1;
FIG. 5 is a right side view of the antenna shown in FIG. 1;
FIG. 6 is a left side view of the antenna shown in FIG. 1;
FIG. 7 is a top view of the antenna shown in FIG. 1; and,
FIG. 8 is a bottom view of the antenna shown in FIG. 1.

1 Claim, 6 Drawing Sheets

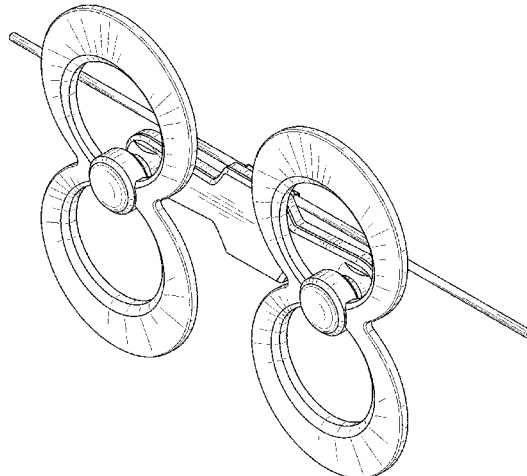

Related U.S. Application Data

application No. 12/040,464, filed on Feb. 29, 2008, now Pat. No. 7,839,347, and a continuation of application No. 12/020,133, filed on Mar. 17, 2008, now Pat. No. 7,609,222, said application No. 12/606,636 is a continuation-in-part of application No. PCT/US2008/061908, filed on Apr. 29, 2008, and a continuation-in-part of application No. 12/040,464, filed on Feb. 29, 2008, now Pat. No. 7,839,347, and a continuation-in-part of application No. 12/050,133, filed on Mar. 17, 2008, now Pat. No. 7,609,222.

7,436,973	B2 *	10/2008	Liao	H04R 1/1041 381/370
D581,931	S	12/2008	Pine	
D585,883	S	2/2009	Kaneko	
D598,433	S	8/2009	Schneider et al.	
D598,434	S	8/2009	Schneider et al.	
D598,469	S *	8/2009	Harris, Jr.	D14/203.1
7,609,222	B2	10/2009	Schneider et al.	
D604,276	S	11/2009	Schneider et al.	
D611,460	S	3/2010	Chao	
7,693,570	B2	4/2010	Green et al.	
D624,531	S	9/2010	Fleck et al.	
7,839,347	B2	11/2010	Schneider et al.	
7,839,351	B2	11/2010	Schadler et al.	
7,898,496	B2	3/2011	Olsen et al.	
D638,031	S *	5/2011	Lee	D14/203.3
7,936,311	B2	5/2011	Rowser et al.	
7,990,335	B2	8/2011	Schneider et al.	
D655,692	S *	3/2012	Silverman	D14/217
8,144,069	B2	3/2012	Sadowski et al.	
8,174,457	B1	5/2012	Lam	
D664,564	S *	7/2012	Gillett	D14/203.3
D666,178	S *	8/2012	Schneider	D14/230
8,368,607	B2	2/2013	Schneider et al.	
8,736,500	B1	5/2014	Lam	
D721,737	S *	1/2015	Ahn	D14/240
8,994,600	B2	3/2015	Schneider et al.	
2002/0158798	A1	10/2002	Chiang et al.	
2003/0071757	A1	4/2003	Yamaki	
2004/0090379	A1	5/2004	Fourdeux et al.	
2004/0090385	A1	5/2004	Green	
2004/0113841	A1	6/2004	Louzir et al.	
2004/0217912	A1	11/2004	Mohammadian	
2005/0088342	A1	4/2005	Parsche	
2005/0162332	A1	7/2005	Schantz	
2005/0259023	A1	11/2005	Wang	
2005/0280582	A1	12/2005	Powell et al.	
2006/0033665	A1	2/2006	Yang	
2006/0055618	A1	3/2006	Poilasne et al.	
2006/0077115	A1	4/2006	Oh et al.	
2006/0103577	A1	5/2006	Lee	
2006/0164304	A1	7/2006	Huang et al.	
2007/0069955	A1	3/2007	McCorkle	
2007/0200769	A1	8/2007	Nakano et al.	
2008/0040464	A1	2/2008	Chia	
2008/0094291	A1	4/2008	Bystrom et al.	
2008/0211720	A1	9/2008	Hansen	
2008/0258980	A1	10/2008	Chen et al.	
2008/0291345	A1	11/2008	Schneider	
2009/0058732	A1	3/2009	Nakano et al.	
2009/0073067	A1	3/2009	Soler Castany et al.	
2009/0146899	A1	6/2009	Schneider et al.	
2010/0085269	A1	4/2010	Sadowski et al.	

(56)

References Cited

U.S. PATENT DOCUMENTS

2,437,251	A	3/1948	Frische et al.	
2,480,155	A	8/1949	Masters	
2,589,578	A	3/1952	Sabins	
D170,203	S *	8/1953	Leonard	D14/230
D171,560	S	2/1954	Ritter	
D177,200	S	3/1956	Valiulis	
D179,111	S	11/1956	Ballan	
2,821,710	A	1/1958	Hale	
3,015,101	A	12/1961	Turner et al.	
3,123,826	A	3/1964	Durham	
3,161,975	A	12/1964	McMillan	
3,239,838	A	3/1966	Kelleher	
3,261,019	A	7/1966	Lundy	
3,273,158	A	9/1966	Fouts et al.	
D209,402	S	11/1967	Burlingame	
D211,025	S	5/1968	Callaghan	
3,434,145	A	3/1969	Wells	
3,521,284	A	7/1970	Strom et al.	
3,560,983	A	2/1971	Willie et al.	
3,587,105	A	6/1971	Neilson	
3,721,990	A	3/1973	Gibson et al.	
3,739,388	A	6/1973	Callaghan	
3,828,867	A	8/1974	Elwood	
3,971,031	A	7/1976	Burke	
4,183,027	A	1/1980	Ehrenspeck	
4,184,163	A	1/1980	Woodward	
4,418,427	A	11/1983	Muterspaugh	
D308,521	S *	6/1990	Lonczak	D14/230
D310,671	S	9/1990	Weiss	
4,987,424	A	1/1991	Tamura et al.	
D318,673	S	7/1991	Terk	
D327,690	S *	7/1992	Ogawa	D14/230
D332,262	S	1/1993	Borchardt	
5,280,645	A	1/1994	Nguyen et al.	
D344,731	S	3/1994	Witzky	
D345,982	S *	4/1994	Lucey	D14/230
5,313,218	A	5/1994	Busking	
5,943,025	A	8/1999	Benham et al.	
D414,495	S *	9/1999	Heiligenstein	D14/230
D421,610	S	3/2000	Ghalebi	
6,054,963	A	4/2000	Muterspaugh	
6,239,764	B1	5/2001	Timofeev et al.	
D449,593	S	10/2001	Schultz	
6,590,541	B1	7/2003	Schultze	
6,593,886	B2	7/2003	Schantz	
D480,714	S	10/2003	Wang	
6,680,708	B2	1/2004	Yamaki	
D501,468	S	2/2005	Wang	
6,885,352	B2	4/2005	Lee et al.	
6,917,793	B2	7/2005	Wang	
7,091,925	B1	8/2006	Wang	
7,126,556	B1	10/2006	Wang	
7,209,089	B2	4/2007	Schantz	
D544,471	S	6/2007	Wang	
7,239,290	B2	7/2007	Poilasne et al.	
7,245,266	B1	7/2007	Szente et al.	
D558,189	S	12/2007	Inoue et al.	
7,356,362	B2 *	4/2008	Chang	H04R 1/1033 379/430

FOREIGN PATENT DOCUMENTS

CN	ZL2008301199963	5/2009
CN	101453057 A	6/2009
CN	ZL2008301199978	7/2009
CN	ZL2008300091398	9/2009
CN	203707328 U	7/2014
EM	000946587	5/2008
EP	1555717 A1	7/2005
EP	1653560 A1	5/2006
EP	1753080 A1	2/2007
GB	2263360 A	7/1993
JP	D1213590	6/2004
TW	M24933 U	11/2004
TW	D112283	8/2006
TW	D119092	9/2007
TW	200926506 A	6/2009
TW	D129744	7/2009
TW	D129745	7/2009
TW	D129746	7/2009
WO	WO-2009073249 A1	6/2009

* cited by examiner

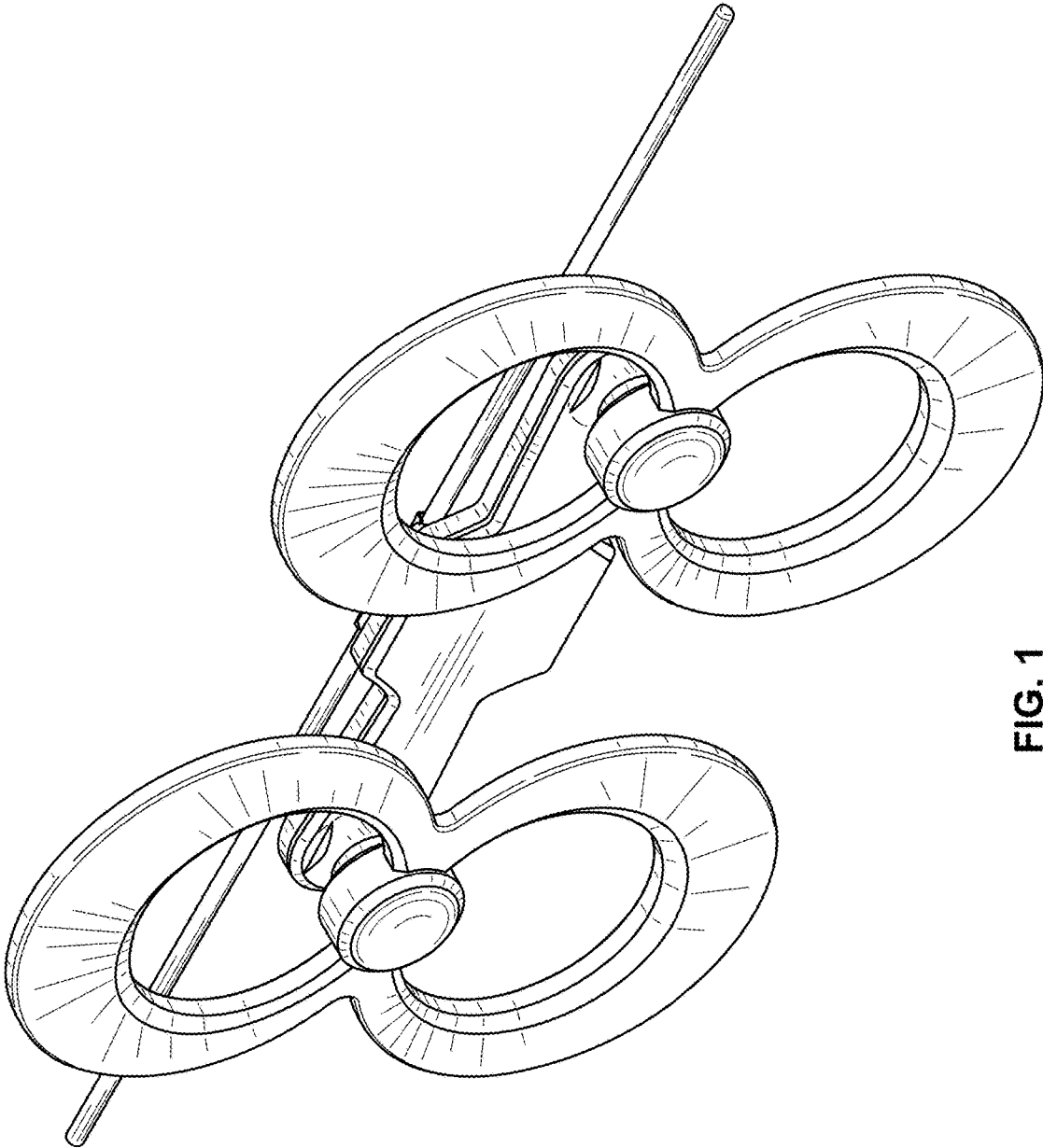

FIG. 1

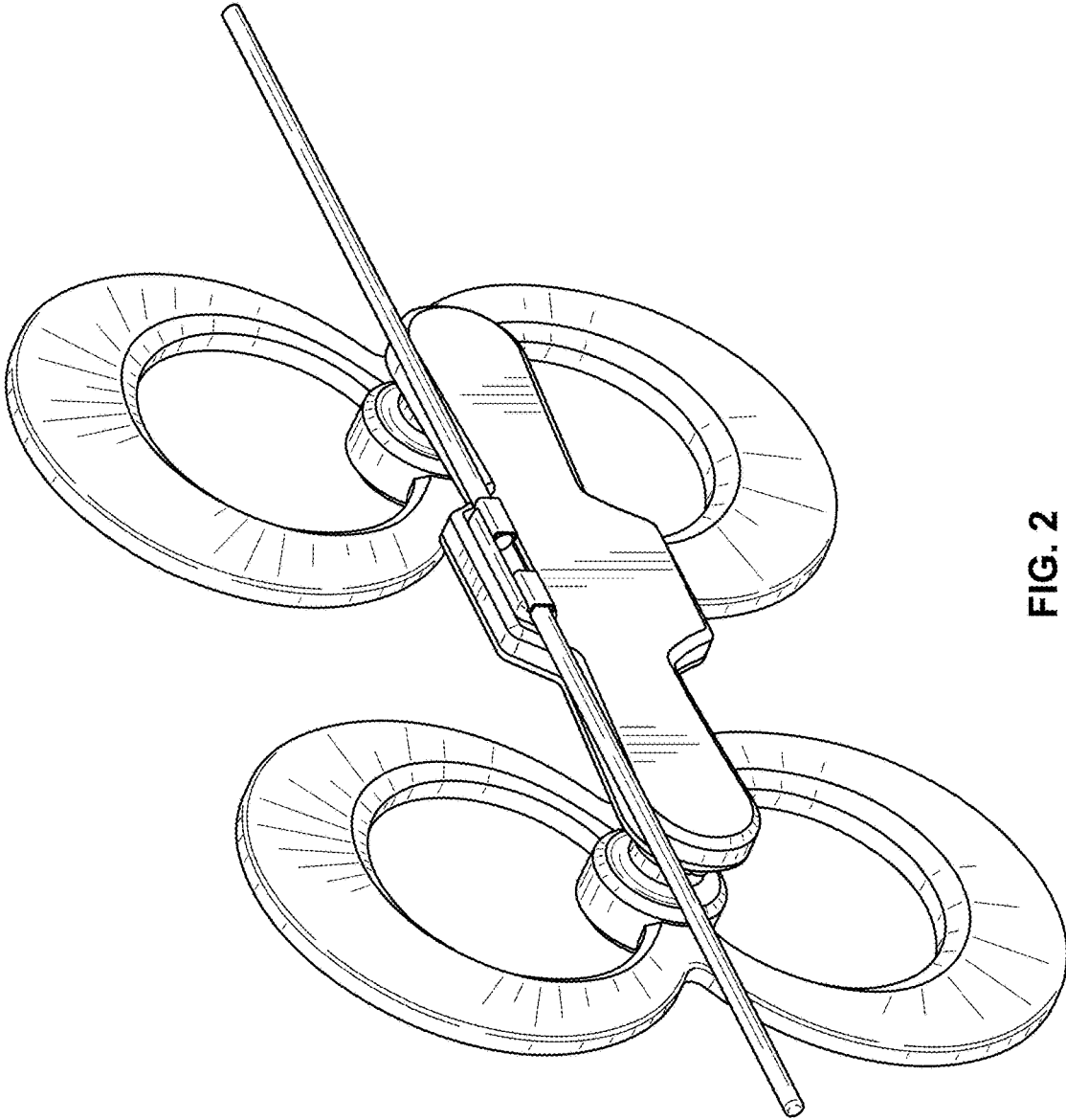

FIG. 2

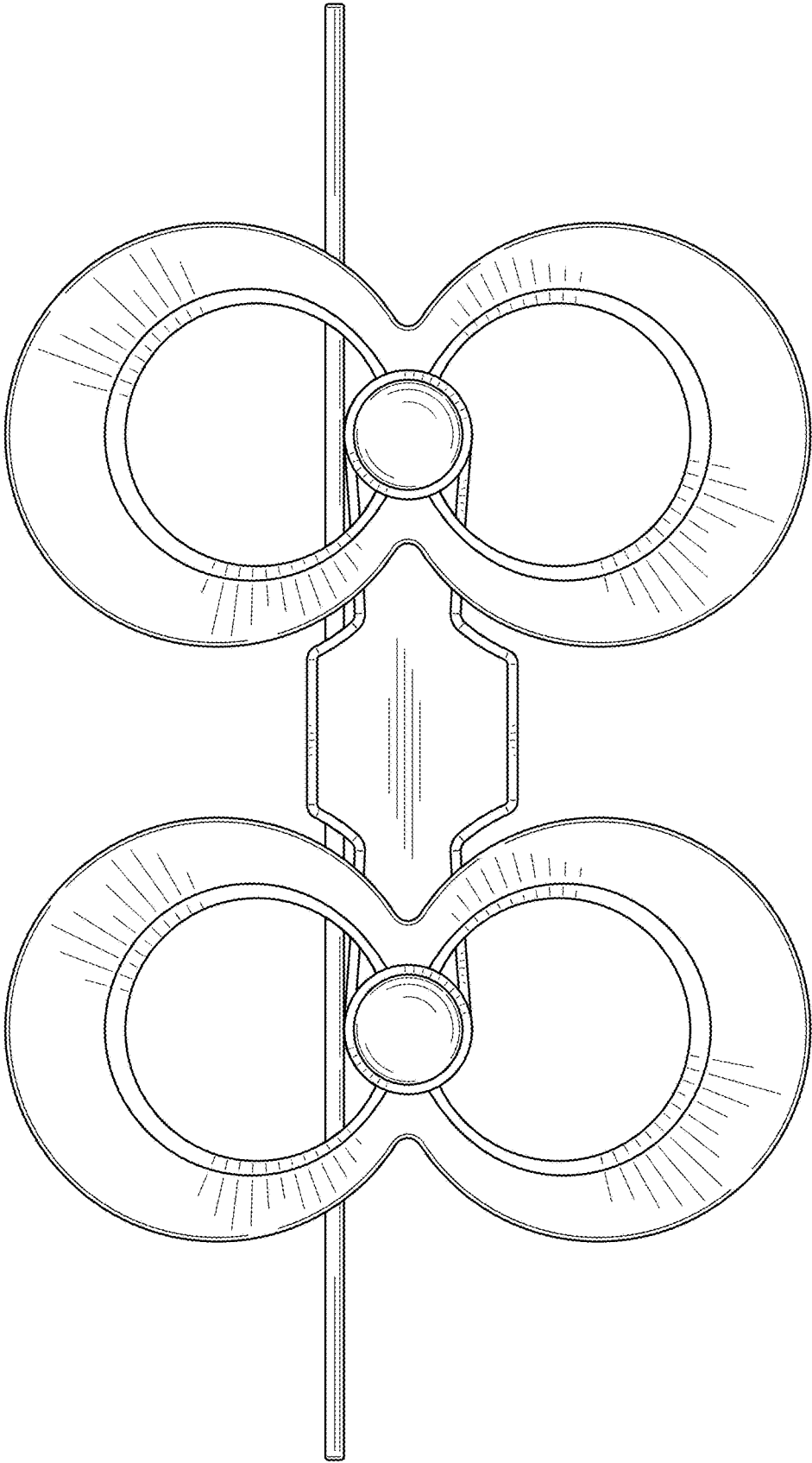

FIG. 3

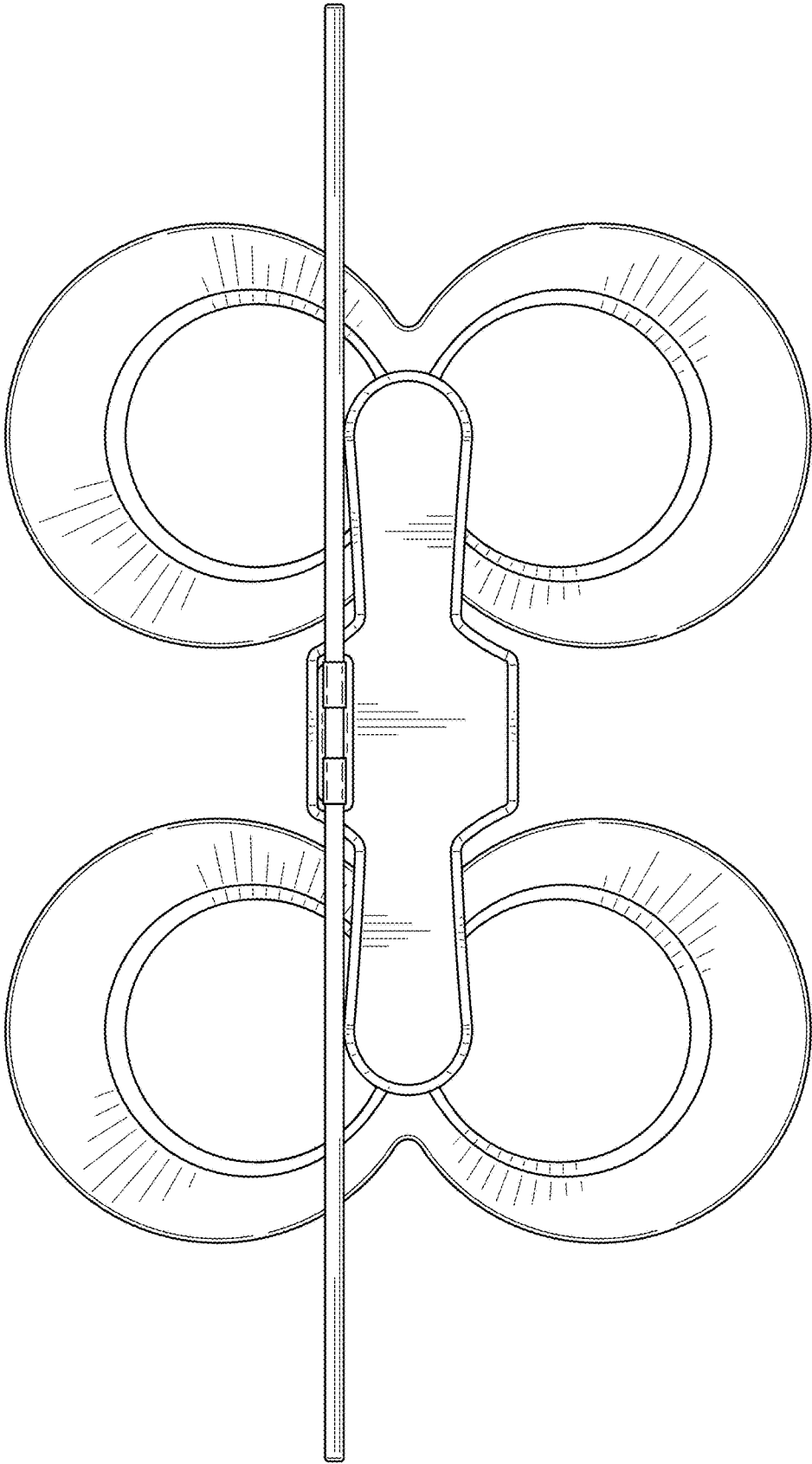

FIG. 4

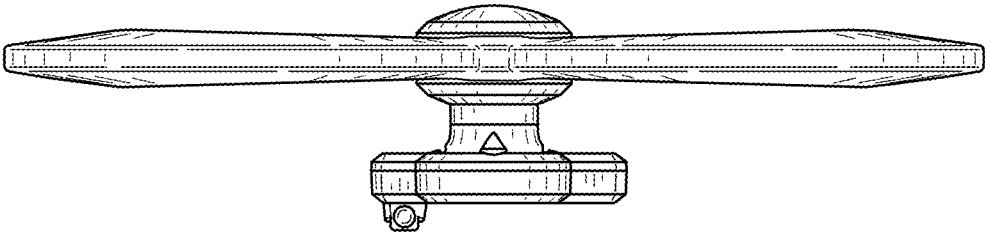

FIG. 6

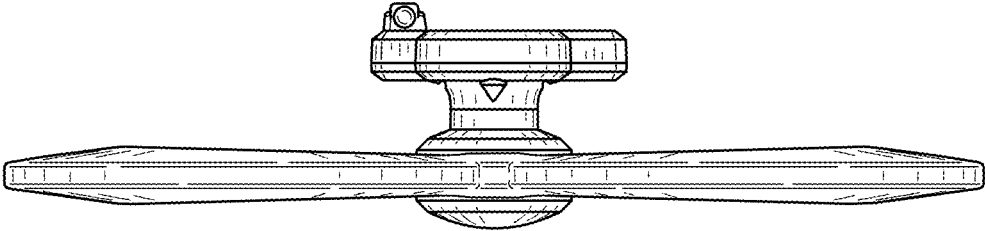

FIG. 5

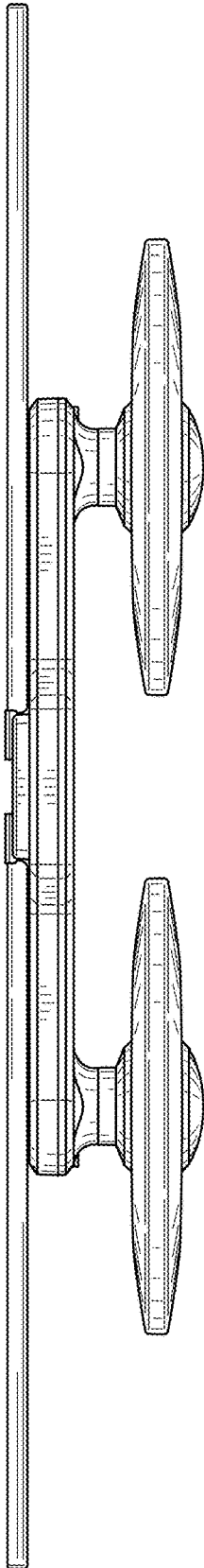

FIG. 7

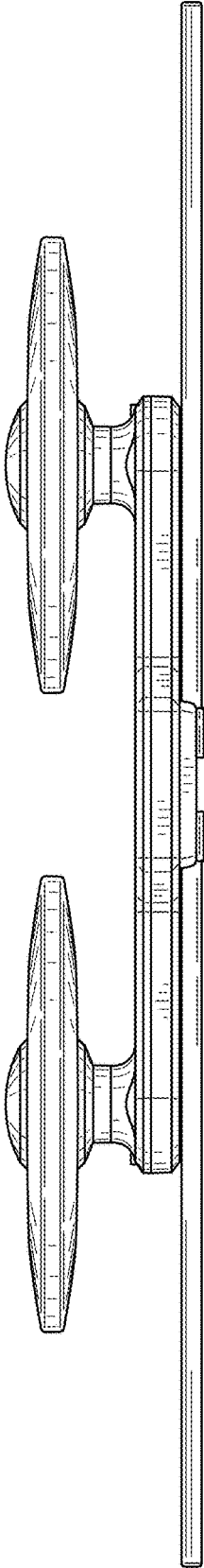

FIG. 8